







D10

PRODUCT INFORMATION:

The D10 LED work light has a unique dome shape which perfectly integrates into your machine. With a 2500 effective lumen output, this work light really helps illuminate your work area in clear, bright, white light. The domed shape also allows for efficient cooling and the D10 can be mounted in a standing or hanging position with a symmetric or asymmetric lens pattern.



-  EMC TESTED
-  IP 69K
-  VIBRATION TESTED *
-  SALT SPRAY TESTED *

* Pending

Operating Temp: -40° to 85°C

Light Pattern: Symmetric,
Asymmetric

Lens Material: Plastic

Housing: Cast Aluminium

Mounting Options:
Hanging, Standing

Connector:
Deutsch (DT04-2P) built in

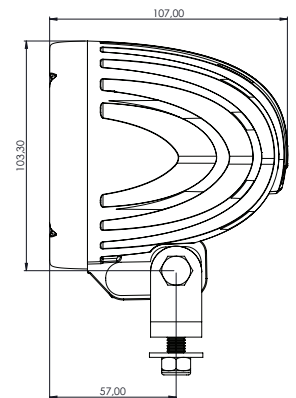
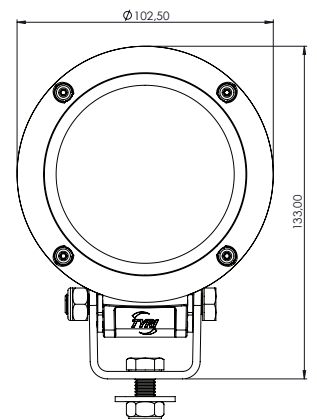

LUMEN OUTPUT		Number of LED'S	VOLTAGE			AMP DRAW		Power (Watts)	Colour Temp	CRI	COMPLIANCE / RATING						
Theoretical	Effective		Machine	Operating Range		12 Volts	24 Volts				EMC EN55025 / CISPR25	IP69K	Vibration 5-2000Hz 3 Axis	Salt Spray ASTM B117	UL Rated Optional	E Approved Optional	Shock Tested
3000	2500	10	12-48	9	60	3.2	1.6	42	5000	70	5	•	10 Grms*	••			

* pending

LED LIGHT BEAM PATTERNS

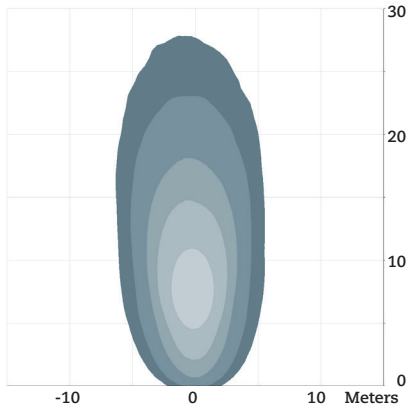

D10 - 2500
Narrow 0-30°
3.0m / -15°
Symmetric

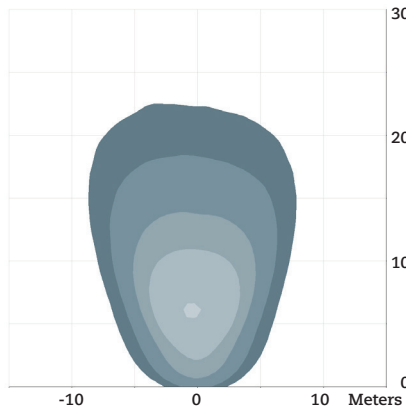

D10 - 2500
Medium 31-45°
3.0m / -15°
Symmetric

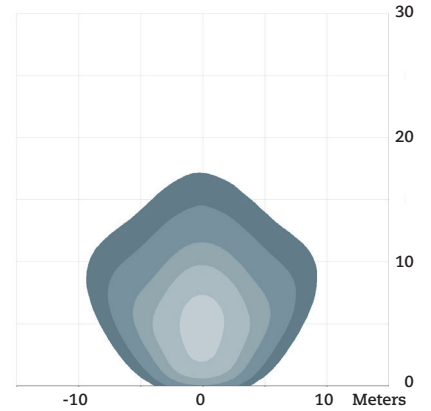

D10 - 2500
Wide 45°+
3.0m / -15°
Asymmetric

